

SECTION - 13

INTESTINAL AND RECTAL

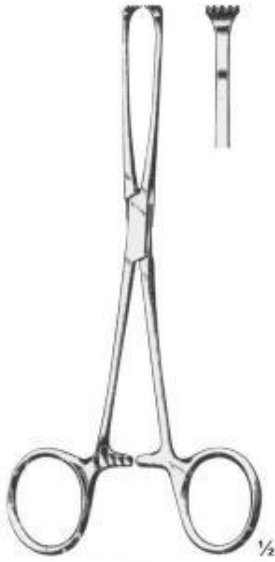

INTESTINAL & RECTAL



ALLIS
 13-001-150
 15 cm
 3 x 3 teeth
 4 x 5 teeth
 5 x 6 teeth



JUDD-ALLIS 3:4
 13-002-150 15.0 cm
 13-003-190 19.0 cm



LOCKWOOD
 13-004-200
 20 cm

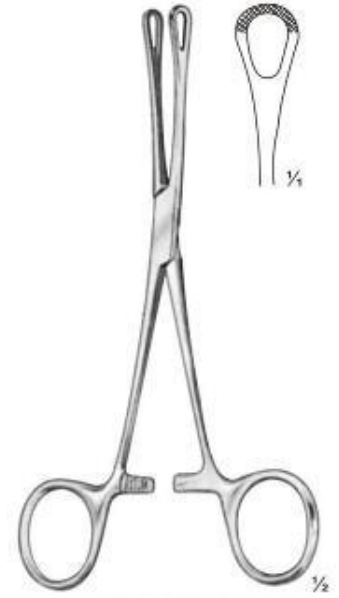

WILLIAMS
 13-005-160
 16 cm



BABCOCK
 13-006-160 16 cm 8 mm
 13-007-180 18 cm 10 mm
 13-008-200 20 cm 13 mm



LANE
 13-009-150 15 cm
 13-010-180 18 cm
 13-011-200 20 cm



LITTLE WOOD
 13-012-190
 19 cm, Box Joint,

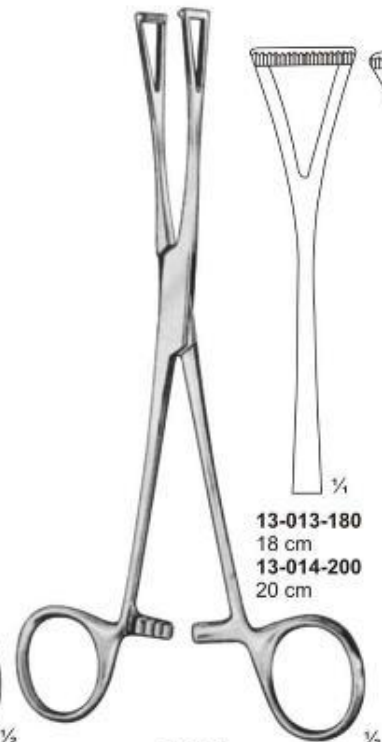

DUVAL
 13-013-180 18 cm
 13-014-200 20 cm
 13-015-200 20 cm
 13-016-230 23 cm

INTESTINAL & RECTAL

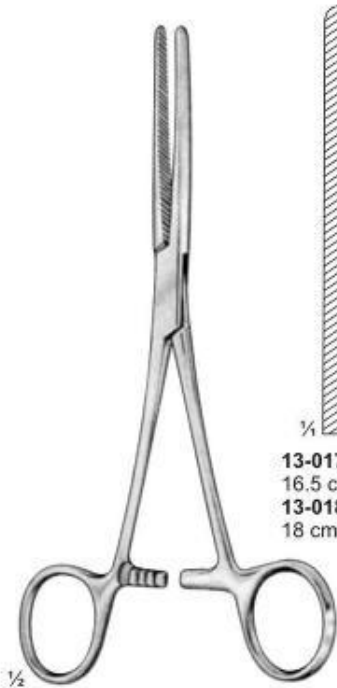

13-017-165
16.5 cm
13-018-180
18 cm

BABY-DOYEN



13-019-165
16.5 cm
13-020-180
18 cm



13-021-210
21 cm
13-022-230
23 cm
13-023-250
25 cm

MAYO-ROBSON



13-024-210
21 cm
13-025-230
23 cm
13-026-250
25 cm

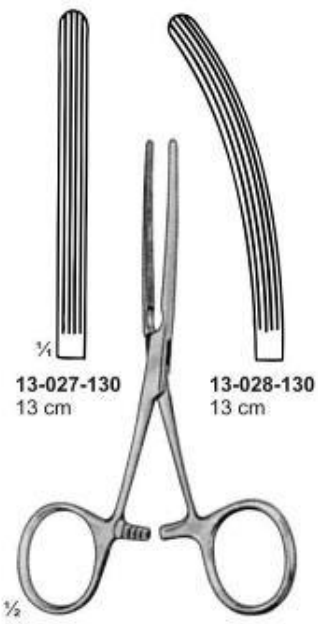

13-027-130
13 cm

13-028-130
13 cm

BABY-KOCHER



13-029-220
22 cm
Straight

KOCHER



13-030-220
22 cm
Curved, grooved

DOYEN

INTESTINAL & RECTAL

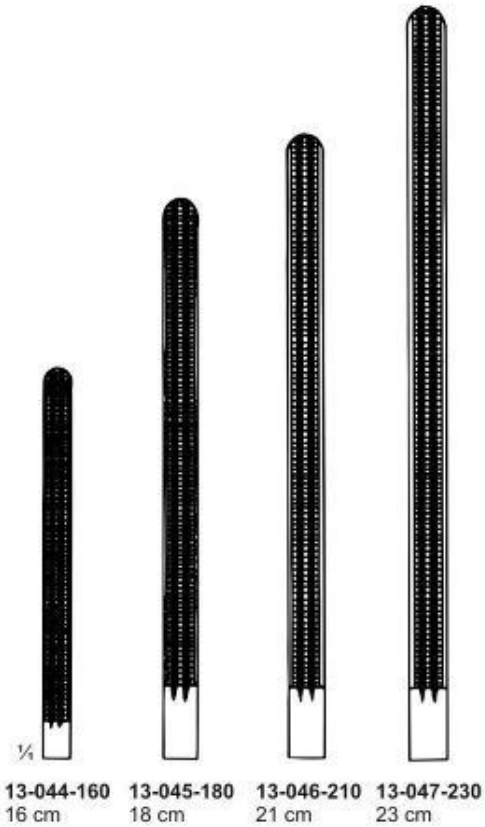
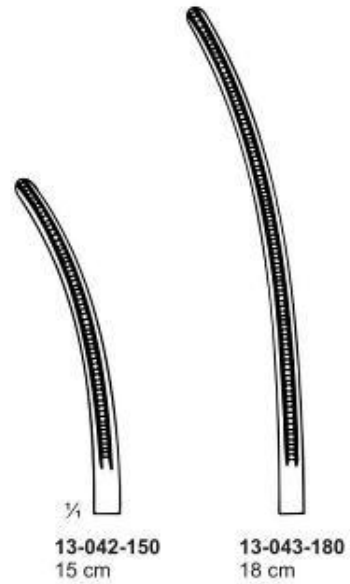
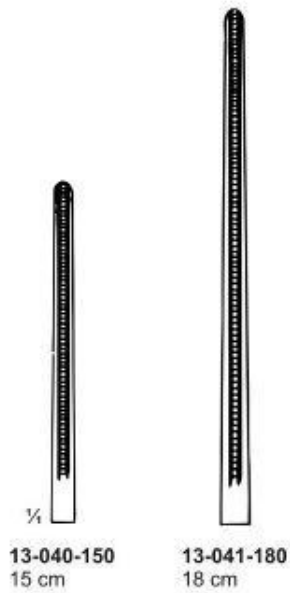

INTESTINAL & RECTAL



NUSSBAUM



13-052-250
25 cm

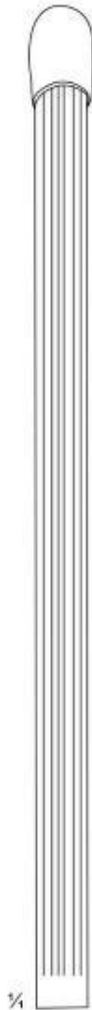

13-053-250
25 cm



SCUDDER



13-054-250
25 cm
13-055-330
33 cm



13-056-250
25 cm
13-057-330
33 cm

INTESTINAL & RECTAL

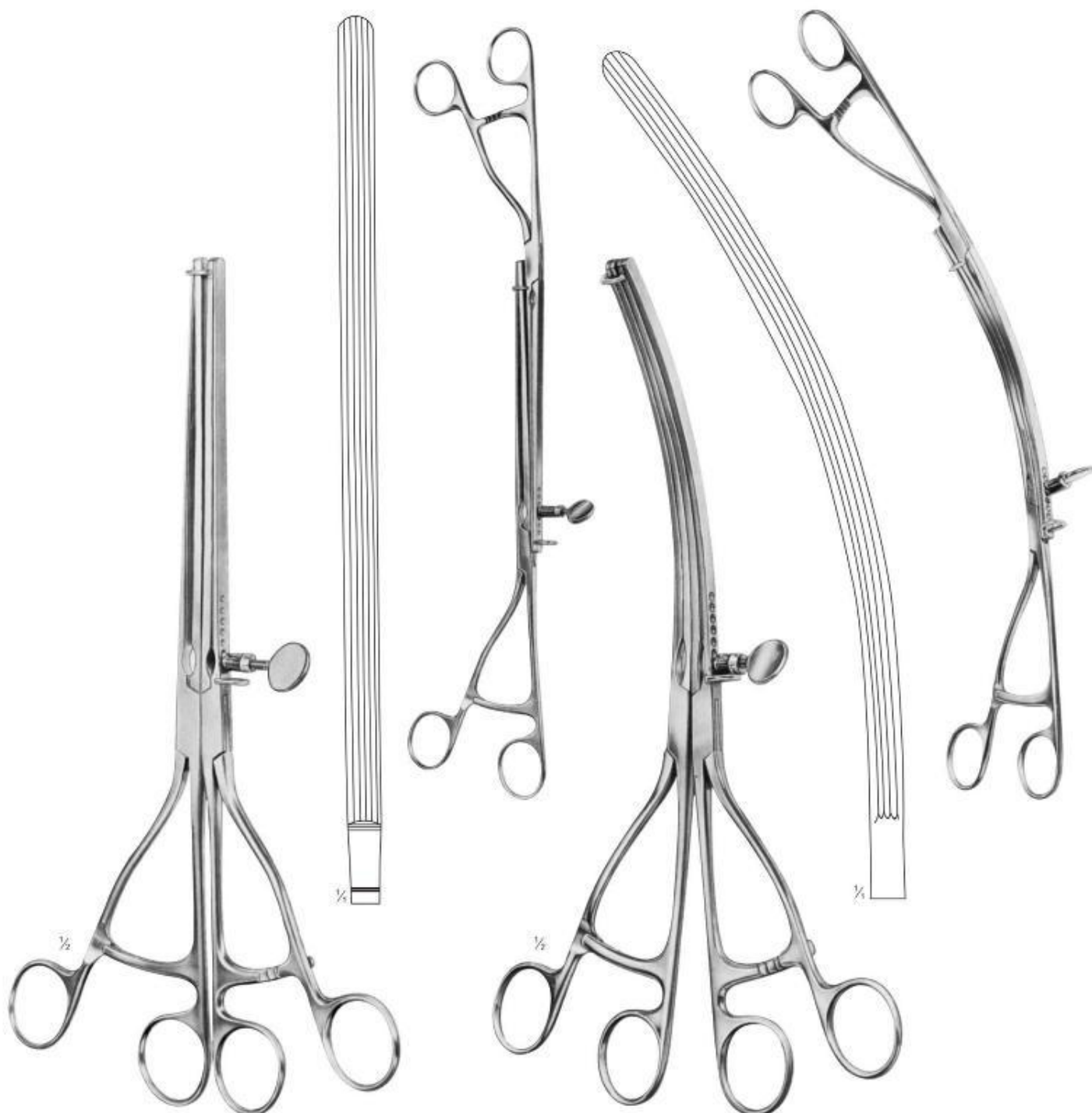

LANE Str.
13-058-300
30 cm

LANE Cvd.
13-059-300
30 cm

INTESTINAL & RECTAL

omax
INTERNATIONAL



$\frac{1}{4}$
PAYR-BABY
13-060-150
15.0 cm
without pin
13-061-150
15.0 cm
with pin

$\frac{1}{2}$
PAYR
13-062-210
21.0 cm
without pin
13-063-210
21.0 cm
with pin

$\frac{1}{2}$
PAYR
13-064-290
29 cm
without pin
13-065-290
29 cm
with pin

$\frac{1}{2}$
PAYR
13-066-350
35 cm
without pin
13-067-350
35 cm
with pin

INTESTINAL & RECTAL

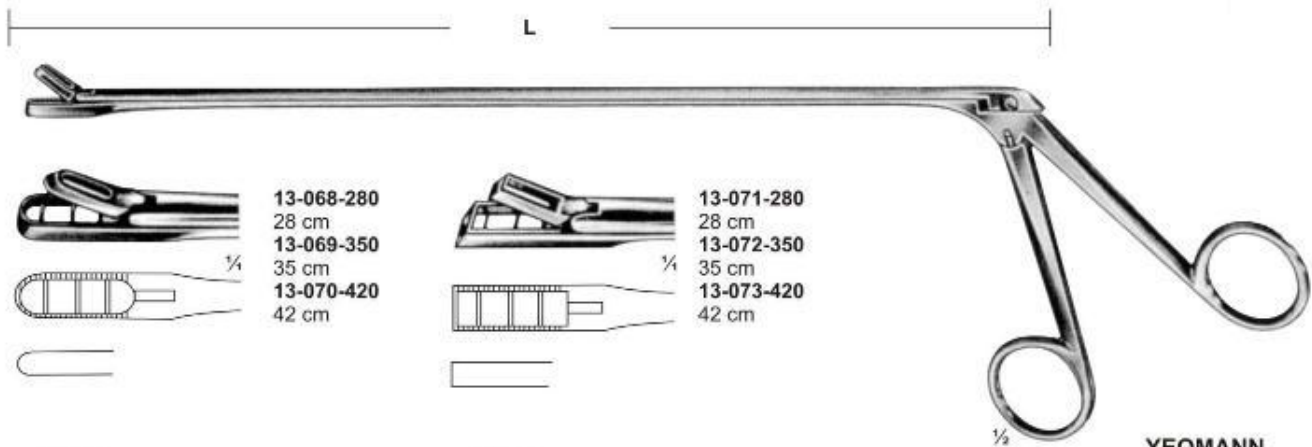

YEOMANN

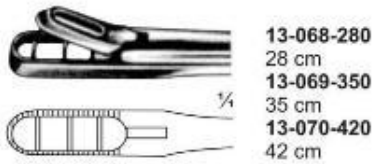

13-068-280
28 cm
13-069-350
35 cm
13-070-420
42 cm

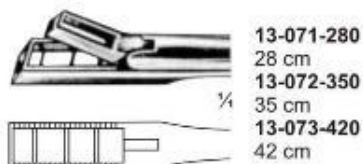

13-071-280
28 cm
13-072-350
35 cm
13-073-420
42 cm

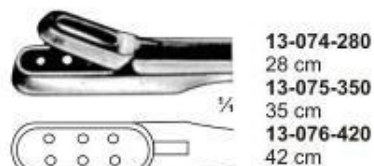

13-074-280
28 cm
13-075-350
35 cm
13-076-420
42 cm

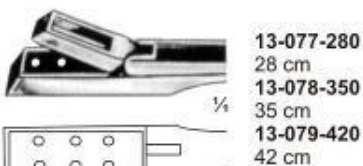

13-077-280
28 cm
13-078-350
35 cm
13-079-420
42 cm

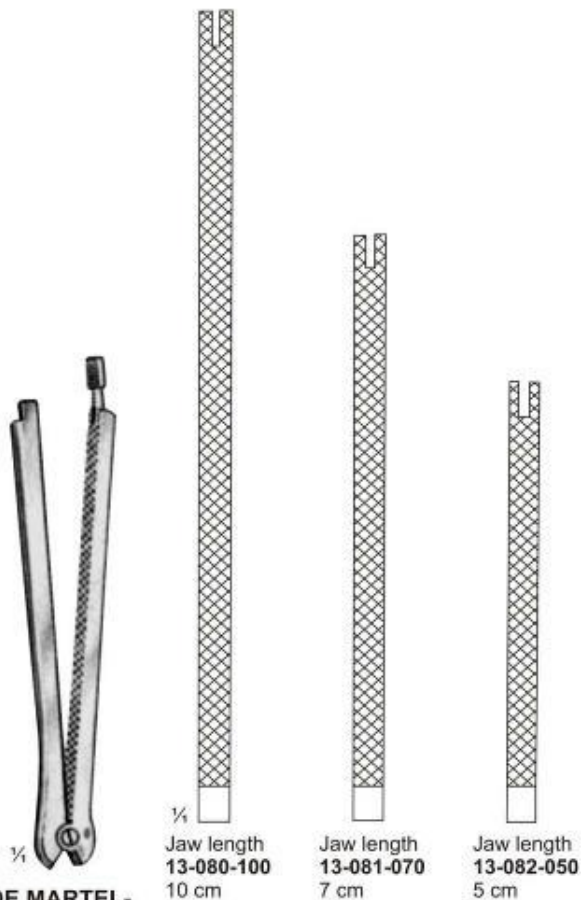

DE MARTEL-WOLFSON
set of 3
anastomosis clamps

Jaw length
13-080-100
10 cm

Jaw length
13-081-070
7 cm

Jaw length
13-082-050
5 cm

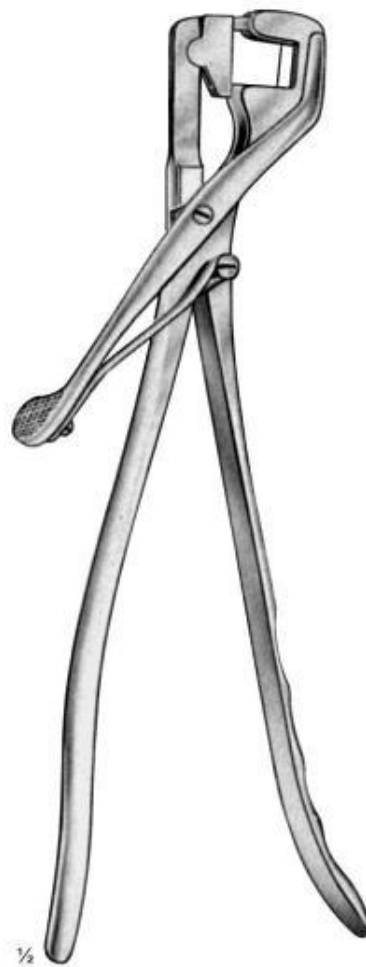

DE MARTEL-WOLFSON
13-083-260
26.0 cm

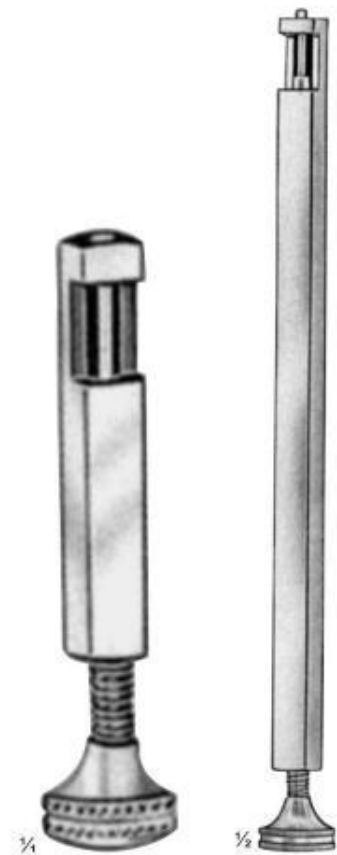

13-084-085
8.5 cm

DE MARTEL-WOLFSON
13-085-230
23 cm

INTESTINAL & RECTAL



1/2

MATHIEU
13-086-195
19.5 cm
90 x 15 mm



1/2

SIMS
13-087-150
15.0 cm



1/2

SIMS
13-088-150
15.0 cm



1/4

IVES-FANSLER
13-089-080
8 cm
80 x 22 mm



1/2

PRATT
13-090-215
21.5 cm
85 x 25 mm blade

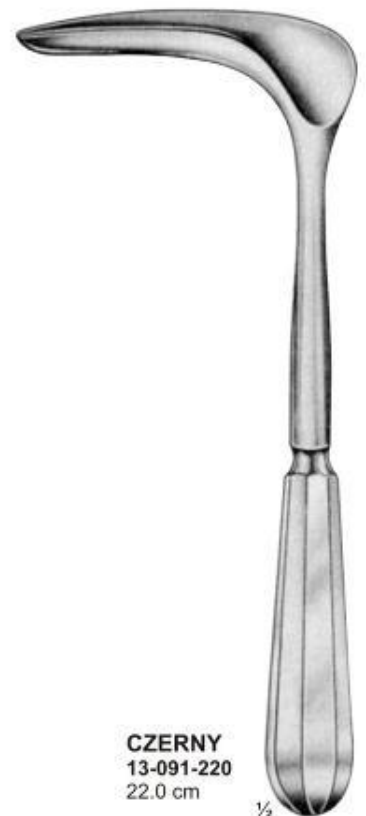

1/2

CZERNY
13-091-220
22.0 cm



- 13-092-00**
16 ø x 65 mm
- 13-093-00**
19 ø x 65 mm
- 13-094-00**
22 ø x 65 mm
- 13-095-00**
22 ø x 125 mm

HIRSCHMANN

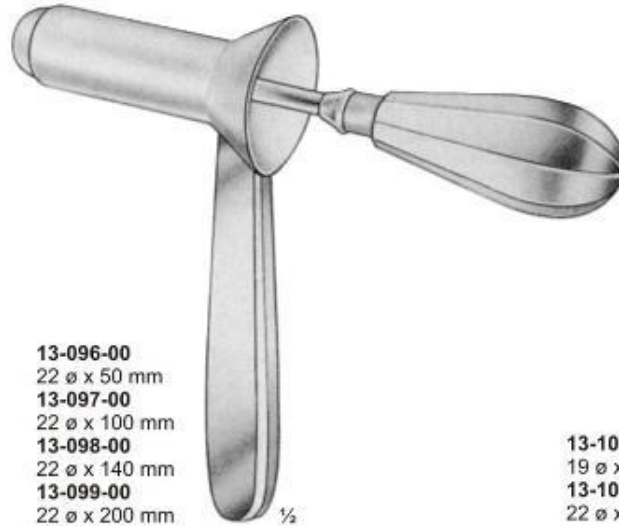

- 13-096-00**
22 ø x 50 mm
- 13-097-00**
22 ø x 100 mm
- 13-098-00**
22 ø x 140 mm
- 13-099-00**
22 ø x 200 mm

KELLY



- 13-100-00**
19 ø x 70 mm
- 13-101-00**
22 ø x 70 mm

BENSAUDE



- 13-102-150**
15 cm
75 x 23 mm

SMITH-BLUE



SCHULZE-BERGMANN

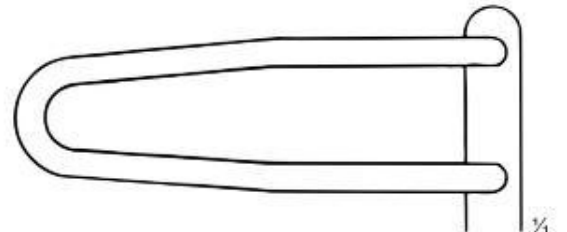

- 13-103-220** 22 cm
60 mm
- 13-104-220** 22 cm
80 mm
- 13-105-220** 22 cm
125 mm
- 13-106-220** 22 cm
150 mm

1/4

INTESTINAL & RECTAL T.C

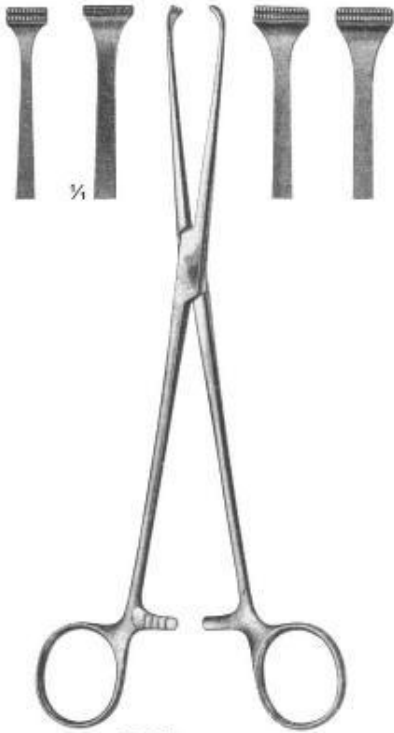

ALLIS
13-107-150 15 cm
13-108-200 20 cm
13-109-220 22 cm
13-110-250 25 cm
13-111-300 30 cm

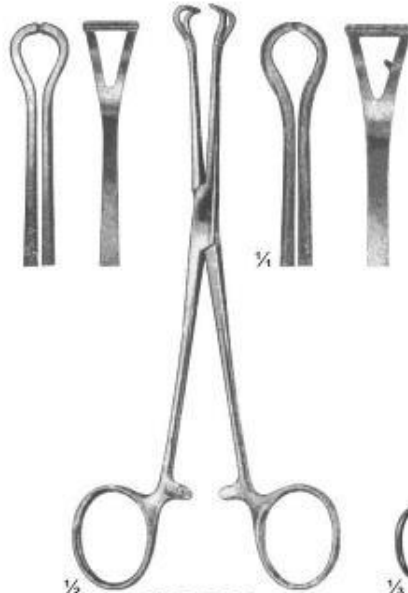

BABCOCK
13-112-160 16 cm
13-113-215 21.5 cm



DUVAL
13-114-250 25 cm
13-115-270 27 cm



BABCOCK



13-116-165 16.5 cm
13-117-203 20.3 cm

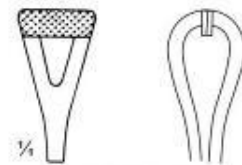

13-118-175 17.5 cm

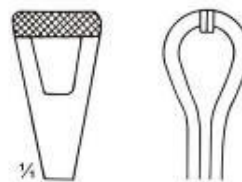

13-119-195 19.5 cm



DUVAL

13-120-130 13 cm

13-121-180 18 cm